

ASSEMBLY INSTRUCTION

1

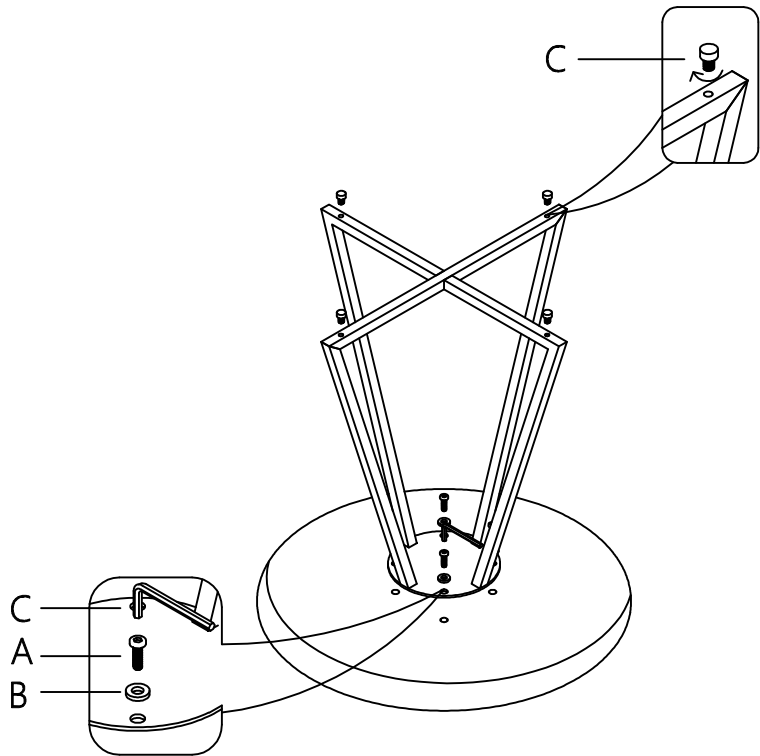

2

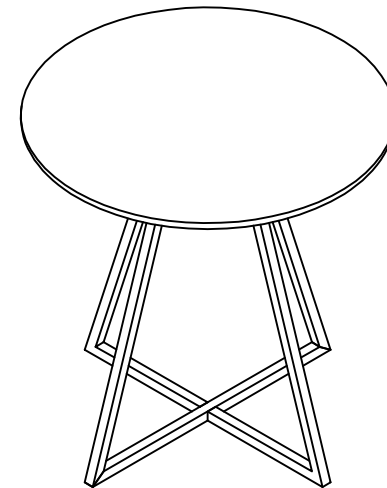

A



X4

B



X4

C

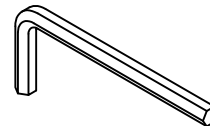

X1

D



X4